

LED PRESETTABLE TRI-WHITE DOWN LIGHT INSTRUCTION

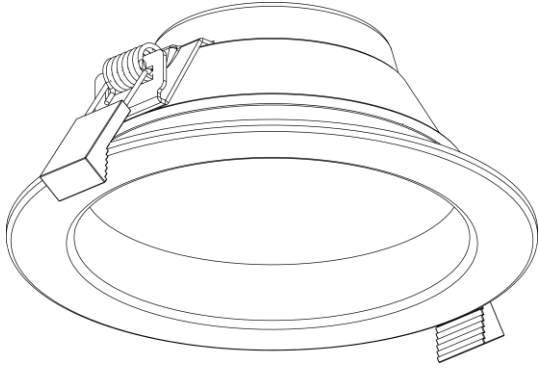

Description:

It adopts high brightness high quality LED as luminous body with low-voltage constant current driver, low power consumption, long lifespan, reliability and safety. Color temperature could be switched in advance. The housing, which is elegant and stylish, is made of high-purity aluminum with spraying coating. Good thermal management ensures stable working of LED, and controls light attenuation effectively.

Perfect optical design ensures soft and even light. Instant lighting, no flickering, no glaring. Free of lead, mercury and other harmful substances. This product is widely used in shopping mall, hotel, restaurant and etc.



Notes

- ◆ Only qualified electrician is allowed to do the installation, maintenance and inspection for safety concern. It is dangerous for non-professional operator.
- ◆ Ceiling-installation only.
- ◆ Do not install the product in high temperature or humid place.
- ◆ no cover on the light at any time.
- ◆ Storage conditions: room temperature, dry environment.

Installation:

Picture 1. Turn off the power.

Picture 2. Drill a suitable mounting hole on ceiling according to size requirement of different item.

Picture 3. Use dip switch to select desired color temperature.

Picture 4. Connect input end of LED converter to commercial power (220V-240V), and make sure connecting way is right.

Picture 5. Put LED driver at suitable place on ceiling.

Picture 6. Pinch both springs, then push light into installation hole, hangers rebound and chuck automatically. Make sure the light fixed well.

Picture 7. Double-check everything is well-connected, and then turn on the power.

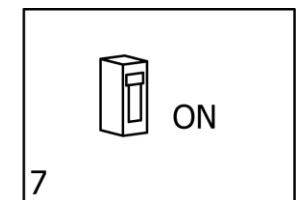
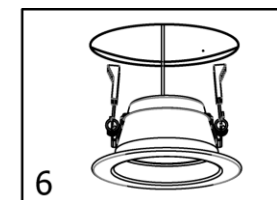
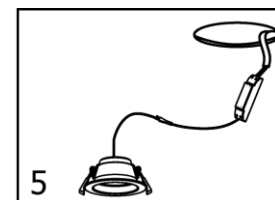
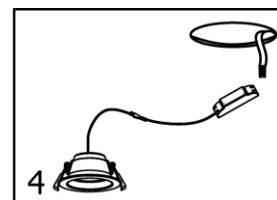
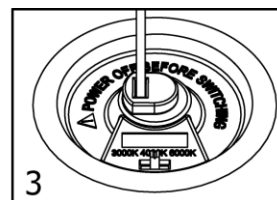
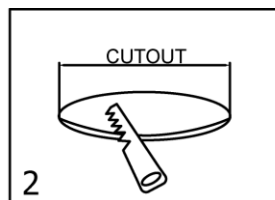
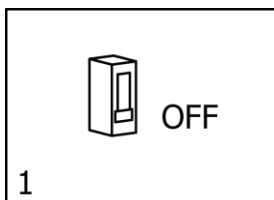

LED Down Light Series

Technical parameters:

	DT090	DT120	DT170	DT195
Input Voltage(VAC)	220-240V AC			
Current(mA)	250	350	350	500
Power (W)	10	14	15	20
Color Temperature(K)	3000 (WW) /4000 (NW) /5000 (CW)			
Luminous Flux (Lm)	780/850/850	1090/1170/1170	1200/1290/1290	1730/1880/1880
Lifespan (hour)	50000			
Cutout(mm)	Φ90-98	Φ117-127	Φ168-178	Φ192-210
Working Temperature(°C)	-20~40			
CRI(Ra)	>80			

Dimension:

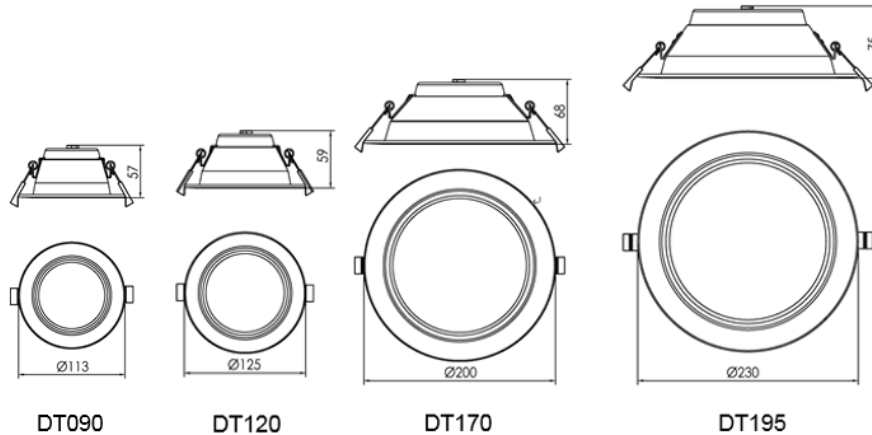

The minimum distance from the top of the luminaire to any normally flammable building element is 40 mm.

The minimum distance from the top of the luminaire to any building insulation is 40 mm.

The minimum distance from the side of the luminaire to any normally flammable building element is 25 mm.

The minimum distance from the side of the luminaire to any building insulation is 40 mm.

Keep at least 150mm distance between driver and the luminaire.

Warning



- * Power should be cut off before installation, maintenance or inspection.
- * Please install and use the light strictly according to the instruction.
- * Do not disassemble or remold the product at will to avoid accident of electric shock or light falling.
- * Working out of temp. range -20°C ~ +40°C will shorten the lifetime of luminaires