

Foreword

Thanks for choosing our LED High Bay Light. We strongly recommend you to read this manual carefully before installation and usage. Make sure you have completely understood the assembly instructions so as to ensure normal working of LED High Bay Light.

Safety Warnings

In order to ensure a perfect quality of the product and a safe usage, please kindly follow the instructions:

1. Before opening the package, please check if there's damage or defect during transportation, if damage occurs, please don't use it and inform your supplier immediately.
2. Should the product be found damaged in any way, please keep it in package and contact your supplier in time.
3. Please do not attempt to use a damaged product.
4. The product should be installed, dismantled and maintained by a qualified electrician; Suppliers don't take charge of any problems or damages that occur due to mishandling such as an operation not permitted in this manual.
5. Choose an install place where can withstand 10 times the weight of the product to ensure a solid installation.
6. Wipe the lamp shade and lens with soft cloth dipped a little neutral detergent, be sure not to use any sandpaper, polishing powder or alcohol, gasoline and so on liquor.
7. A High Pressure Air Blower is recommended to clean the heat sink of this LED High Bay Light.
8. To avoid the risk of fire, explosion, or electric shock, this product should be installed, inspected, and maintained by a qualified electrician only, in accordance with all applicable electrical codes.
9. Be certain electrical power is OFF before and during installation and maintenance.
10. The external flexible cable or cord of this luminaire cannot be replaced; if the cord is damaged, the luminaire shall be destroyed.
11. The light source of this luminaire is not replaceable; when the light source reaches its end of life the whole luminaire shall be replaced.
12. Terminal block not included. Installation may require advice from a qualified person.
13. IP65 can be used indoor only.
14. Shall be installed out of arms reach.



15. Caution, risk of electric shock.
16. Mounting height at 5-15m.

This manual applies to this model product only, for more information, please contact our staff.

USER MANUAL

LED High Bay Light

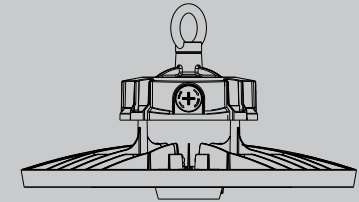

CONTENTS

Product dimension	1
Optional spare parts	1
Installation	2-3
Lighting range	4
Foreword	5
Safety warnings	5

Product Dimension(mm)

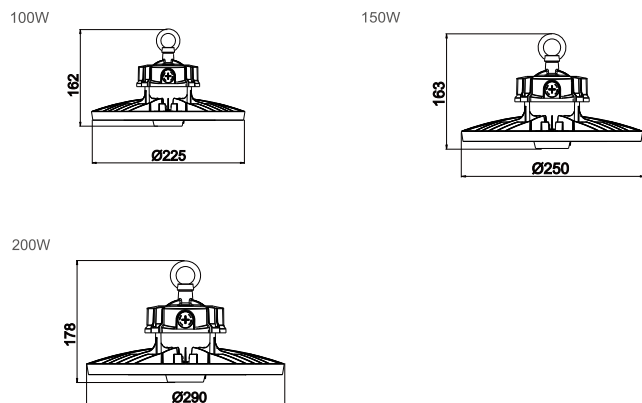

Optional Spare Parts

A:Lampshade option and replacement:

- 1)Match 4pcs screw holes between lampshade and veil;
- 2)Screw out 4pcs screws of the veil at right place;
- 3)Put the lampshade onto the luminaires and make sure all screw holes matched again.

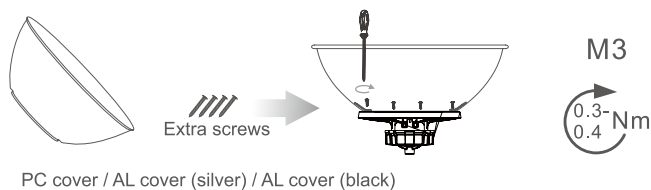

PC cover / AL cover (silver) / AL cover (black)

Installation

A: Suspended installation

- 1.Take out the high bay light and put up right ,and then check to make sure the lamp body is all right.

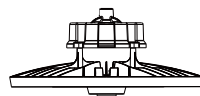

- 2.As shown in picture below:

Rotate the suspension loop till it is fixed onto the high bay light and screw in the security bolt for safety concern,then hang the lamp directly with the snap hook in the right place.

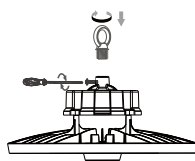

Mounting height at 3-15m.

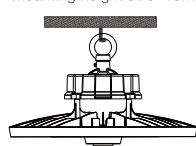

B: Bracket installation

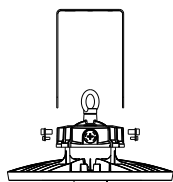

- 1.Prepare the brackets and screws.

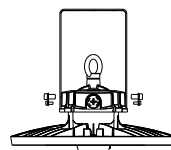

- 2.Align the brackets and screws with the holes.

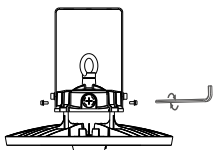

- 3.tighten the screws

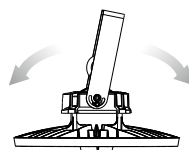

- 4.Adjust the mounting bracket to the desired angle and install it in a safe position.

Installation

IMPORTANT

POWER selections MUST NOT be changed whilst the product is energized.

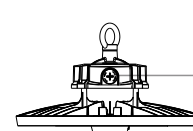

Open this

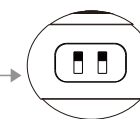

Power and CCT Dip Switch

	Power	Power	Power
LOW	60W	100W	120W
MID	80W	120W	150W
HIGH	100W	150W	200W

	CCT
NW	4000K
PW	5000K
w	6000K

Make connection with mains supply as per following instruction and light up.

Standard Cable Config:

- 1.With 1.5m European plug cable
- 2.diameter of 3x1.0mm
- 3.Wire stripping Tin 10mm

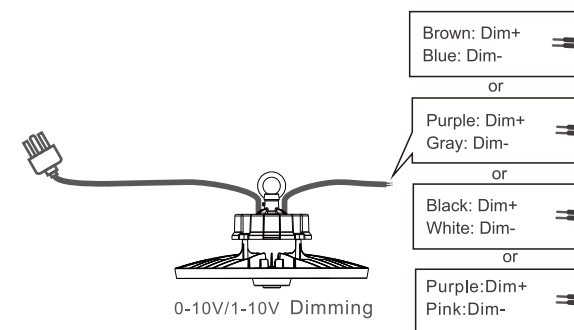

0-10V/1-10V Dimming