

Slimline Spotlight

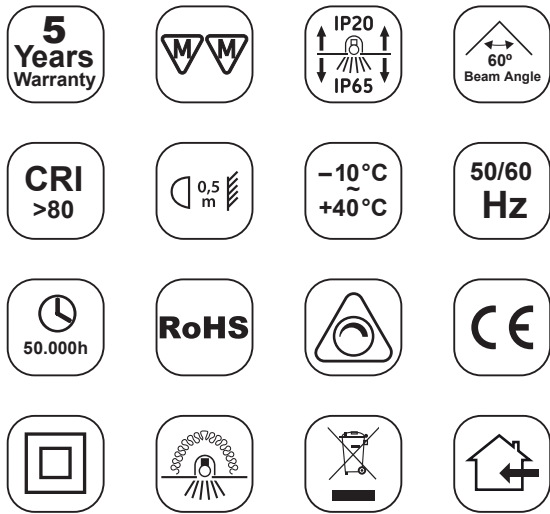

Warning

1. Installation only to be carried out by qualified electrician
2. Please ensure surface is suitable and capable of holding the luminaire and driver weight
3. Pre-cut hole before installation, (see below chart for hole diameter)
4. Do not operate if product is damaged
5. IP65 rated front, suitable for bathroom zones 1 & 2

Product Code:	812089 - 812096 - 812102	CRI:	>80
Primary Material:	Aluminum	Tilt Angle:	±30°
Power:	5W / 7W	IP Rated:	IP65
Color Temperature:	2300K/3000K/4000K	Insulation Covered:	Yes
Dim to warm:	3000-2300K		
Voltage:	220V-240V		
Driver Type:	Non-Isolated		
LED Chips:	HongLI SMD 2835		

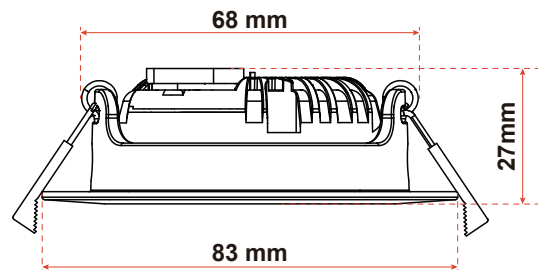

1. This product must be installed by a qualified electrician in accordance with instructions provided and in compliance with recognised electrical and safety regulations relevant to the country it is being installed.
2. The product and its associated control gear are designed to operate on 220-240volts 50Hz.
3. This downlighter range is designed to be installed in a ceiling tile/solid material with a minimum dimension of 3mm thickness.
4. This product is for Indoor use only.

Specific Installation details

1. Ensure the AC/mains power is not connected and cannot be reconnected during installation.
2. For new installations use cutting tools suitable for the material and carefully cut the required hole to allow installation. (Figure 2)
3. For Refurbishment installations ensure that the existing hole is suitable and strong enough to hold the new downlight. Support the surrounding area if required.
4. Connect the AC/mains cable to the driver using the marked terminals provided. Incoming Cable connections are, L=Live power conductor(brown), N = Neutral power conductor(blue). The driver offered is Class II.
5. Remove downlighter from box and connect to the driver via the connection system provided. (Fig.4)
6. Raise the springs and place the downlighter into the tile cut-out ensuring that both the driver and mains power cable are not trapped. (Fig.6)
7. Once correctly connected, position the downlighter fully into the aperture so that the outer flange is flush with the installed ceiling tile/solid material. (Fig 7)

1 Slimline Spotlight

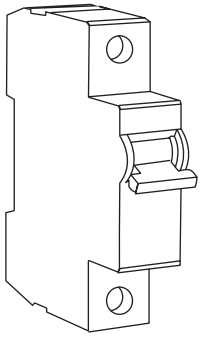

2

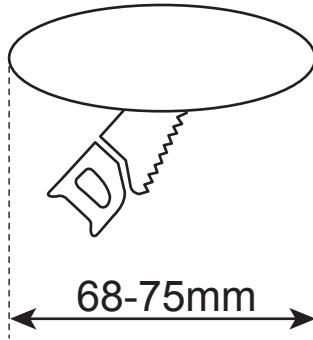

3

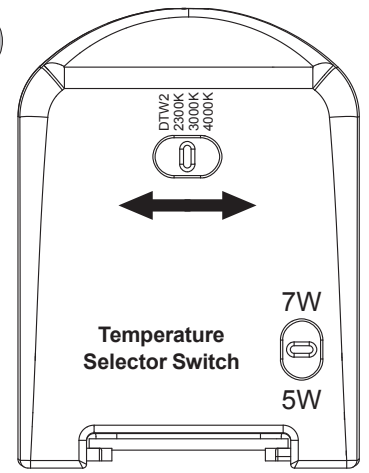

4

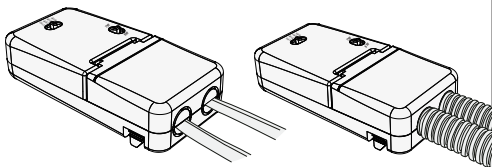
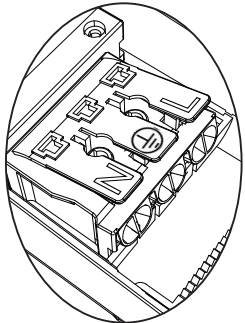
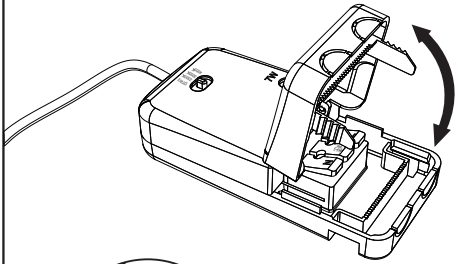
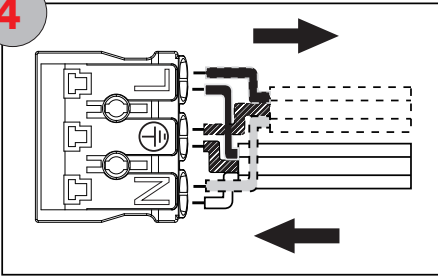

5

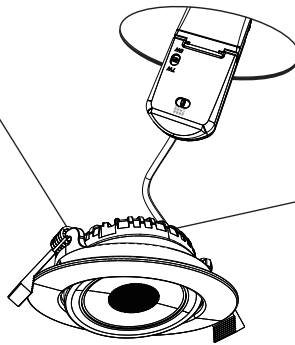

6

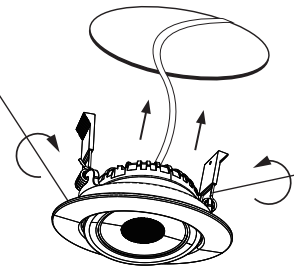

7

↓ IP20

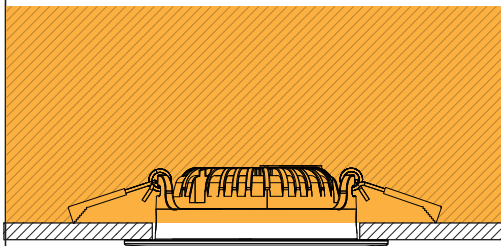

↑ IP65

8

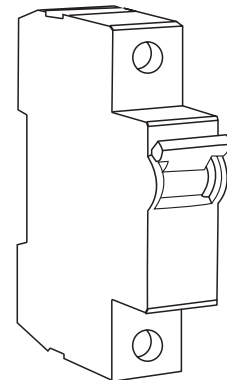

Contact Information:

This product is covered by a 5 year warranty in the EU and UK but the warranty is void in the event of improper use, installation, alteration or breach of specification. Replacement of faulty equipment if required needs to be installed correctly and at your own expense. The provider reserves the right to change product specifications.